



■ Vers. 009



■ Vers. 047+217



■ Vers. 048



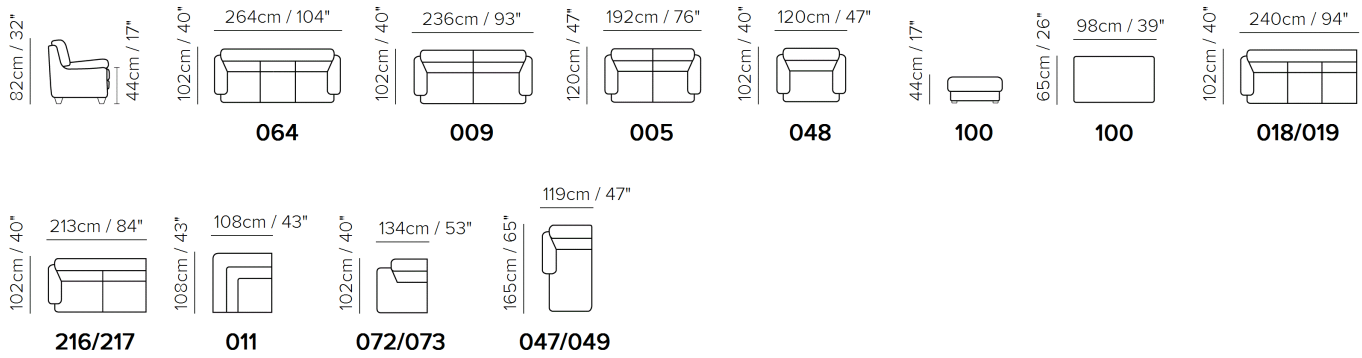

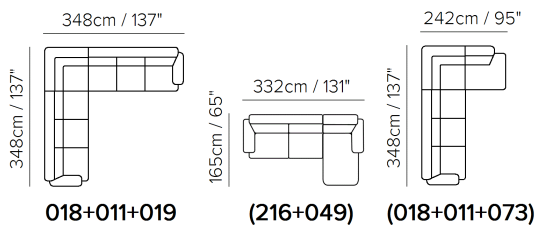

SCHEMATICS



COMPOSITION EXAMPLES



TECHNICAL INFORMATION

	COVERING	Leather <input checked="" type="checkbox"/>	Soft Cover <input checked="" type="checkbox"/>			
	LEGS	Castors <input type="checkbox"/>	Plastic <input type="checkbox"/>	Metal <input checked="" type="checkbox"/>	Wood <input type="checkbox"/>	Upholstered <input type="checkbox"/>
	FILLING	Arms <input type="checkbox"/> Fiber <input checked="" type="checkbox"/> Foam <input type="checkbox"/> Feather/Fiber Mix <input type="checkbox"/> Feather	Seat cushion <input type="checkbox"/> Fiber <input checked="" type="checkbox"/> Foam <input type="checkbox"/> Feather/Fiber Mix <input type="checkbox"/> Feather	Back cushion <input type="checkbox"/> Fiber <input checked="" type="checkbox"/> Foam <input type="checkbox"/> Feather/Fiber Mix <input type="checkbox"/> Feather		
	COMFORT	Standard Comfort <input checked="" type="checkbox"/>	Firm Comfort <input type="checkbox"/>			
	FUNCTION	Bed <input type="checkbox"/>	Electric motion <input type="checkbox"/>	Motion <input type="checkbox"/>	Recliner <input type="checkbox"/>	Sliding <input type="checkbox"/>
	OPTIONS	Nails <input type="checkbox"/>	Contrast Stitching <input type="checkbox"/>	Removable <input type="checkbox"/>		

NOTES

- Tight Seat Cushion (the seat cushions of the models are fixed to the frame)
- Loose Back Cushion (the back cushions of the model are not fixed to the frame)
- No Leather Side (the sectional pieces have the side covered with fabric and not leather)
- Wood Frame
- Without Feet Assembled (the feet will be in a bag inside the package)
- Plastic Wrap (the model will be wrapped in a plastic bag)
- Feet available in metal finishings 75 (Glazed Nickel) / 78 (Black Chrome)
- Feet height 17,0 cm